

Beautiful, safe and very affordable

DISCOVER THE BWT AQUAMATIC
ABOVE-GROUND POOL COVER



PERFECT FOR ANY POOL

... wooden pools included!

BWT Aquamatic secures and protects your pool at an affordable price. **Made in France, this cover is reliable, hard-wearing, effective and efficient.**

Particularly suited to wooden pools, the BWT Aquamatic cover is compatible with all pool configurations, above-ground and in-ground.

THE RELIABILITY OF A MAJOR BRAND

BWT Aquamatic is backed by the talent, expertise and professionalism of a leading European company.

The assurance of quality manufacturing.

SECURITY AND PEACE OF MIND

Compliant with the standard NF P90-308, BWT Aquamatic provides optimal protection against accidental falls into your pool. With this cover you can enjoy your pool fully with total peace of mind.

MADE IN FRANCE

BWT Aquamatic covers are made in Brittany, in western France, by experienced, conscientious specialists who are fully committed to your customer satisfaction.

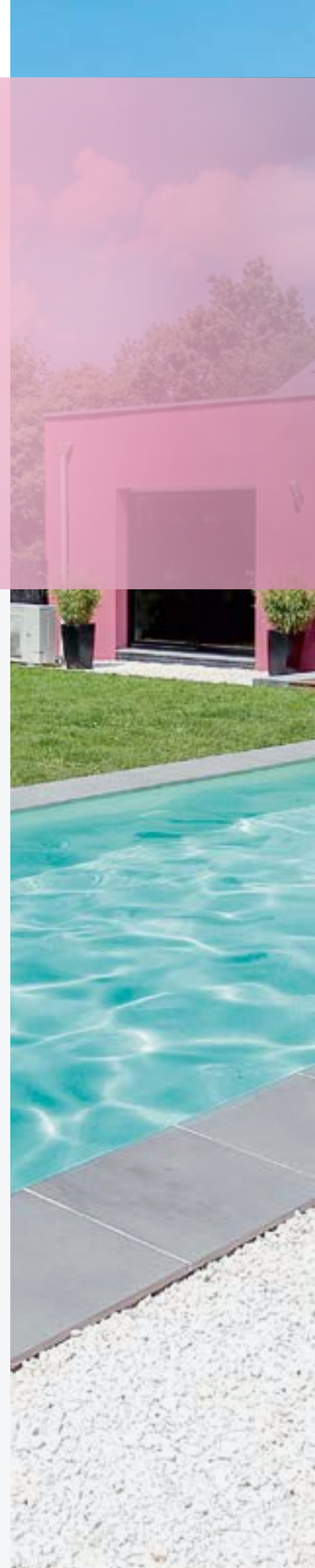



EQUIPMENT

- Anodised Aluminium axle fitted with a drive motor
- 80 N.m motor
- Key switch mounted on the end stand

ADVANTAGES

- Reliability of the ends of travel system
- Discreet appeal
- The grain of the Qualicoat paints helps protect against scratching
- Small end stands (160 × 120 mm)
- Perfect for wooden pools
- NF P90-308 standard compliant



MAXIMUM DIMENSIONS: 5.09 m x 12.00 m

The maximum dimensions of a BWT Aquamatic cover are 5.09 m x 12 m.

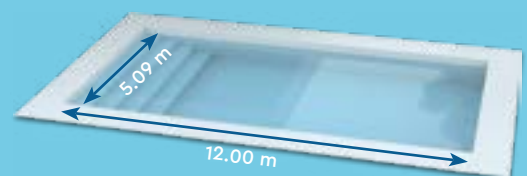

BWT, THE PERFECT SLAT

..by design

BWT slats are the best in every category: **exceptional buoyancy, excellent insulation, extremely reliable.** They were designed to satisfy the most demanding pool owners.

EXCLUSIVE ANTI-TILT MECHANISM

The angle of deflection of the slats is the smallest available on the market (-50° to +15°). This limits the sinking of the slat cover under the weight of a person, and provides better protection in the event of a fall onto the cover.

Featuring rigid slats, each with three air cells, BWT Aquamatic covers are the outright winners in the buoyancy category. An added safety feature.

A BWT exclusive!

REDUCED EVAPORATION FROM INDOOR POOLS

On indoor pools, the cover slats form an effective barrier that prevents evaporation and subsequent condensation on walls and windows. This significantly reduces heat loss and generates cost savings.



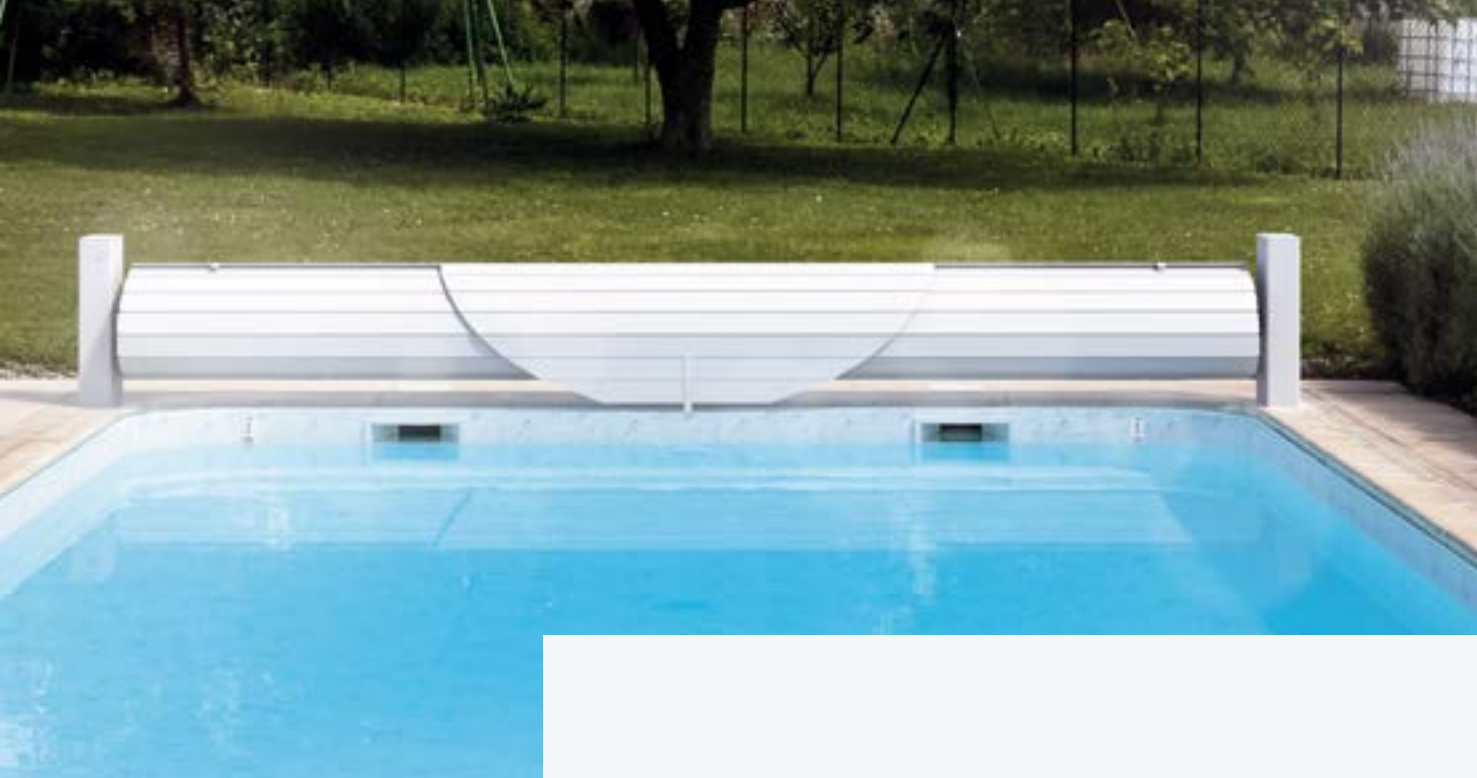

SLAT COVER FEATURES

- Dynamic contour, for excellent transmission of stress loading and easy deployment
- Resists winding in the wrong direction
- Supports the weight of an adult up to 100 Kg
- Slats fastened with hooks
- Ultrasonically welded end plugs ensure that the slat is completely leaktight
- NF P 90-308 standard compliant

PRESENTATION ON DELIVERY

- Delivered in pre-assembled sets of 6 slats, assembly is 2 to 3 times faster
- Slat accessories are mounted in the factory

SLATS THAT SLIDE TOGETHER

The slats are designed to slide together. Ideal for larger pools, this method of assembly is suitable for all types of slat cover. A cleverly designed system, down to the finest detail.

ASSEMBLY BY CLIPPING

An alternative to the sliding assembly method, the clipping method is suitable for pools up to 4 m wide located in areas without much room for manoeuvre.

A WIDE VARIETY OF FINISHES



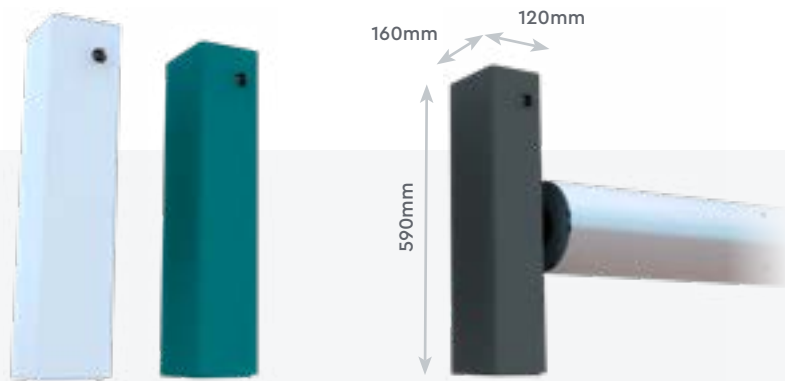

BWT AQUAMATIC OFFERS A CHOICE OF COLORS

■ End stands:

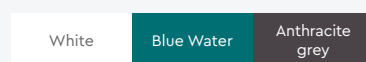

■ Slat :

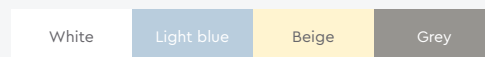

■ Safety fastener systems:

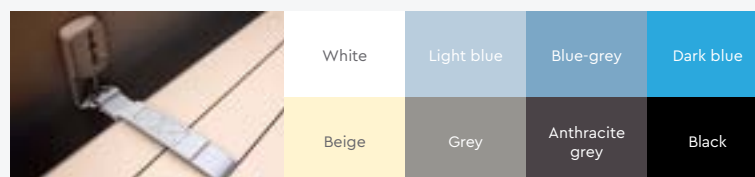

■ Slat cover finishes:

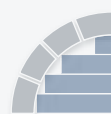

Stepped finish

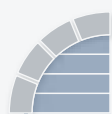

Shaped finish

BWT covers can be made to fit straight steps, roman steps and even free-form steps.

There are two types of finish available: stepped or shaped.

LEGAL NOTICES



The NF P90-308 standard forbids uncovered gaps more than 250 mm wide. In the event of a request for a stepped finish, if this would result in an uncovered gap wider than 250 mm, the finish in that area must and will be smooth.

children under five access to the pool. This cover is no substitute for common sense or individual responsibility. Nor is it intended to replace the vigilance of parents and/ or responsible adults that remains the key factor in ensuring the safety of young children.

BWT covers comply with the French standard NF P 90-308 (as it pertains to the protection of pools by a safety cover) in as far as all items comprising the cover are supplied by BWT. This pool safety cover intended to deny



Dealer's stamp:

A large, empty rectangular box with a thin black border, intended for a dealer's stamp or signature.