

The background image shows a large, rectangular swimming pool with a clear blue sky above. A portion of the pool is covered with a dark, textured automatic cover. The pool deck is light-colored, and there are lounge chairs and trees in the background.

Stardeck protects big, beautiful pools!

FOR EXISTING POOLS & POOLS UNDER CONSTRUCTION

CLASSIC, HIGH WATER LEVEL & INÉO

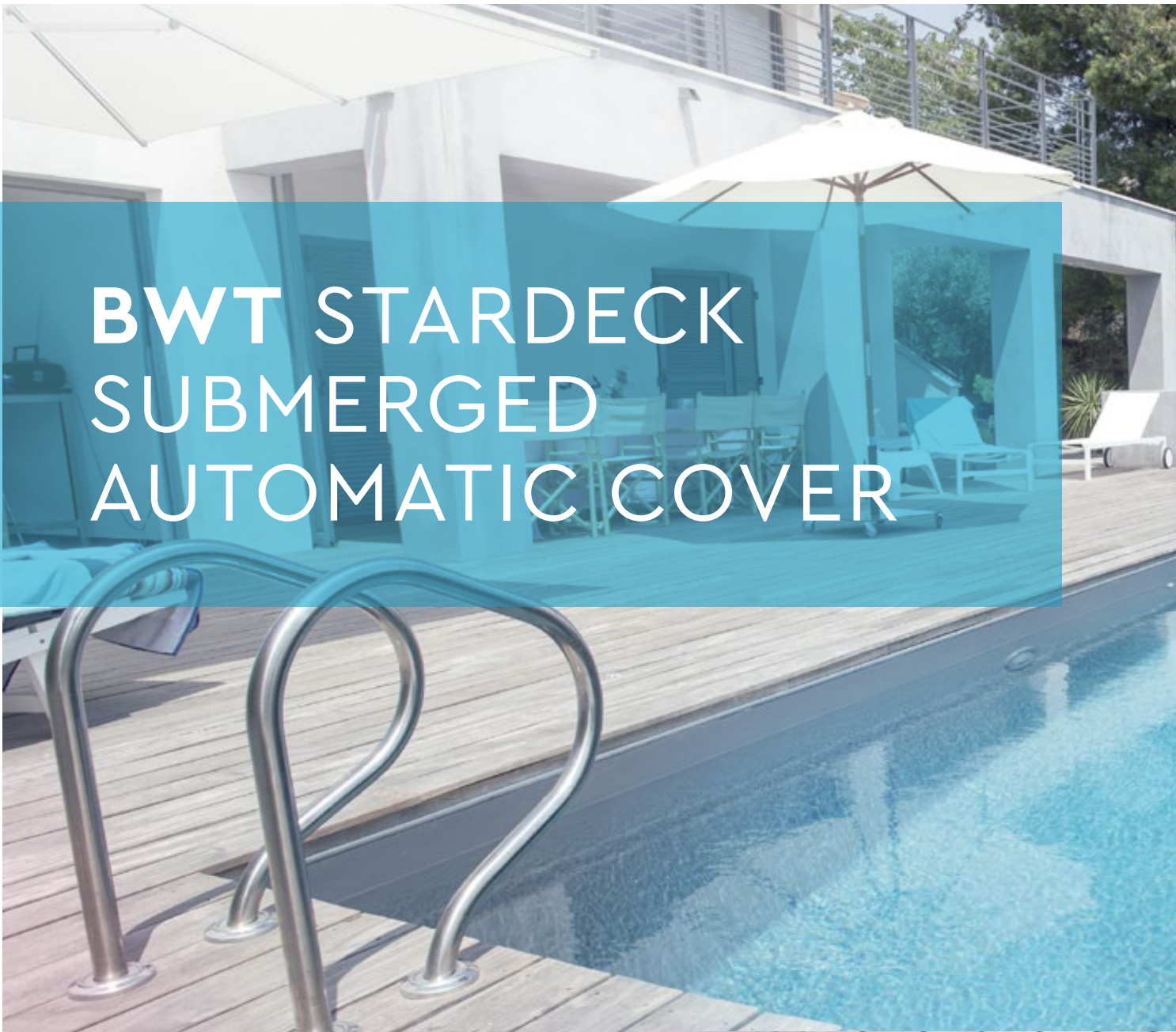

BWT STARDECK SUBMERGED AUTOMATIC COVER

Stardeck, is the professional reference for pools under construction.

Stardeck's design blends beauty with flawless functionality, it is particularly suited to very large pools.

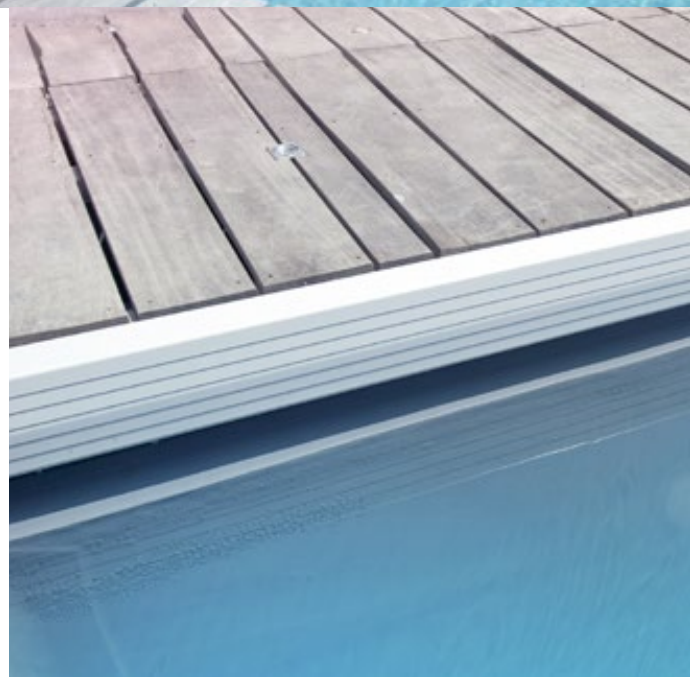



FLAWLESS BEAUTY

Your cover is completely hidden, Stardeck has no visual impact on the look of your pool.

TECHNICAL GENIUS

With its powerful, high torque motor and adapted mechanical assembly, Stardeck is suitable for pools up to 12.09 m wide or up to 25 m long.

New slats!

BWT, THE PERFECT SLAT

BWT slats are the best in every category: exceptional bouyancy, excellent insulation, highly reliable. They were designed to satisfy the most demanding pool owners.

They are also acclaimed by professionals, who appreciate their special contour and cleverly thought out method of assembly.

- Dynamic contour, for excellent transmission of stress loading and easy deployment,
- Resists winding in the wrong direction,
- Attached with hooks,
- Ultrasonically welded end plugs ensure that the slat is completely leaktight.

SLATS THAT SLIDE TOGETHER

The slats, delivered in pre-assembled sets of six, are slid together. With no clipping required, this method of assembly protects the slat hinges. A cleverly designed system, down to the finest detail.

EXCLUSIVE ANTI-TILT MECHANISM

The angle of deflection of the slats is the smallest available on the market (-50° to +15°). This limits the sinking of the slat cover under the weight of a person, and provides better protection in the event of a fall onto the cover.

Featuring rigid slats, each with three air cells, Stardeck covers are the outright winners in the bouyancy category. An added safety feature.

A Procopi exclusive!

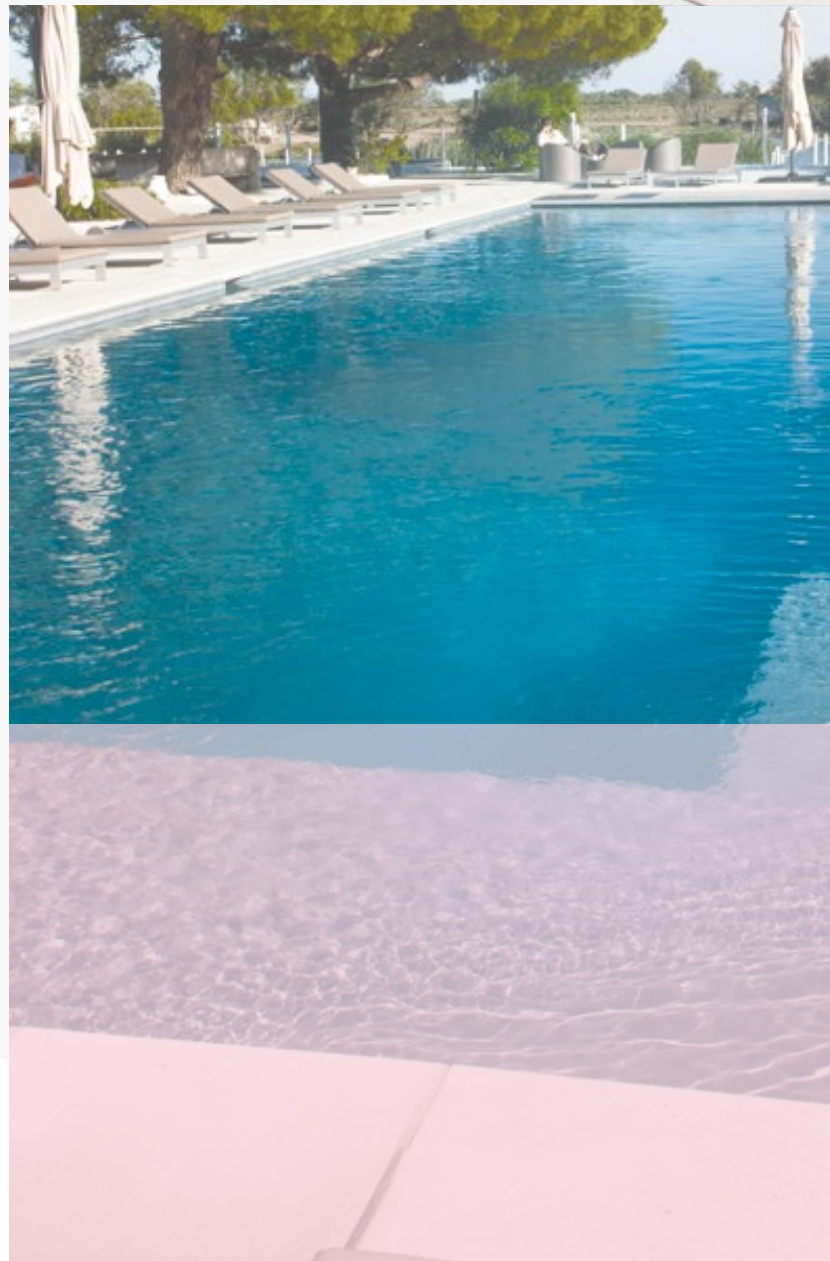



REDUCED EVAPORATION FROM INDOOR POOLS

On indoor pools, the cover slats form an effective barrier that prevents evaporation and subsequent condensation on walls and windows. This significantly reduces heat loss and generates cost savings.

BECOME AN ECOCITIZEN

By keeping your pool clean and reducing the filtration time, Stardeck saves on energy and on pool chemicals, this helps lessen your pool's ecological impact on the environment. Lastly, the PVC slats of your Stardeck cover can be recycled.

NEW: *Polycarbonate slats*

Available only for submerged covers with a stepped finish.

Caution: polycarbonate slats do not allow compliance with the French standard NF P 90-308.

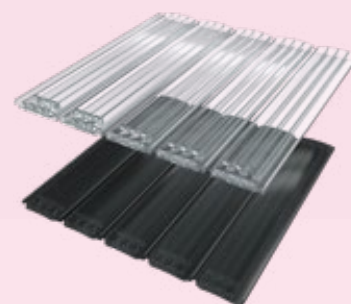



WINTERCLEAN P-F

The WinterClean P-F system is comprised of segments of high density polyethylene that clip onto the slats to cover the space between the slats and pool wall.





BWT offers

THE BEST, MOST BEAUTIFUL PROTECTION



A Stardeck cover, like any BWT cover, is the best available means of preventing an accidental fall into a pool. Stardeck complies with every stipulation of the French pool safety standard, NF P 90-308, and allows you to enjoy your pool with complete peace of mind.

A simple twist of a key and in just a few seconds your cover closes effortlessly over your pool. Your pool is secured, your peace of mind is guaranteed.

BEAUTIFUL

Stardeck combines effective and reliable protection with an undeniable visual appeal. Each cover is designed to harmoniously follow the contour of your pool and the wide choice of slat colours allows you to add an additional touch of refinement.



A SIMPLE, CLEVERLY DESIGNED SYSTEM

Stardeck is a BWT cover, designed and manufactured by a market leader.

STARDECK CLASSIC



See page 6 for more detail.



ANODISED ALUMINIUM AXLE ASSEMBLY

Ø 150 mm, 180 mm or 250 mm

BEAM

Available in 5 colours:

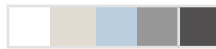

SLAT APRON

Available in 5 colours:

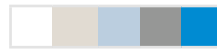

PC SLAT APRON

Available in 2 colours
(not compliant with the NF P 90-308 standard).



DUCKBOARDING

in wood or a choice of 6 PVC colours:

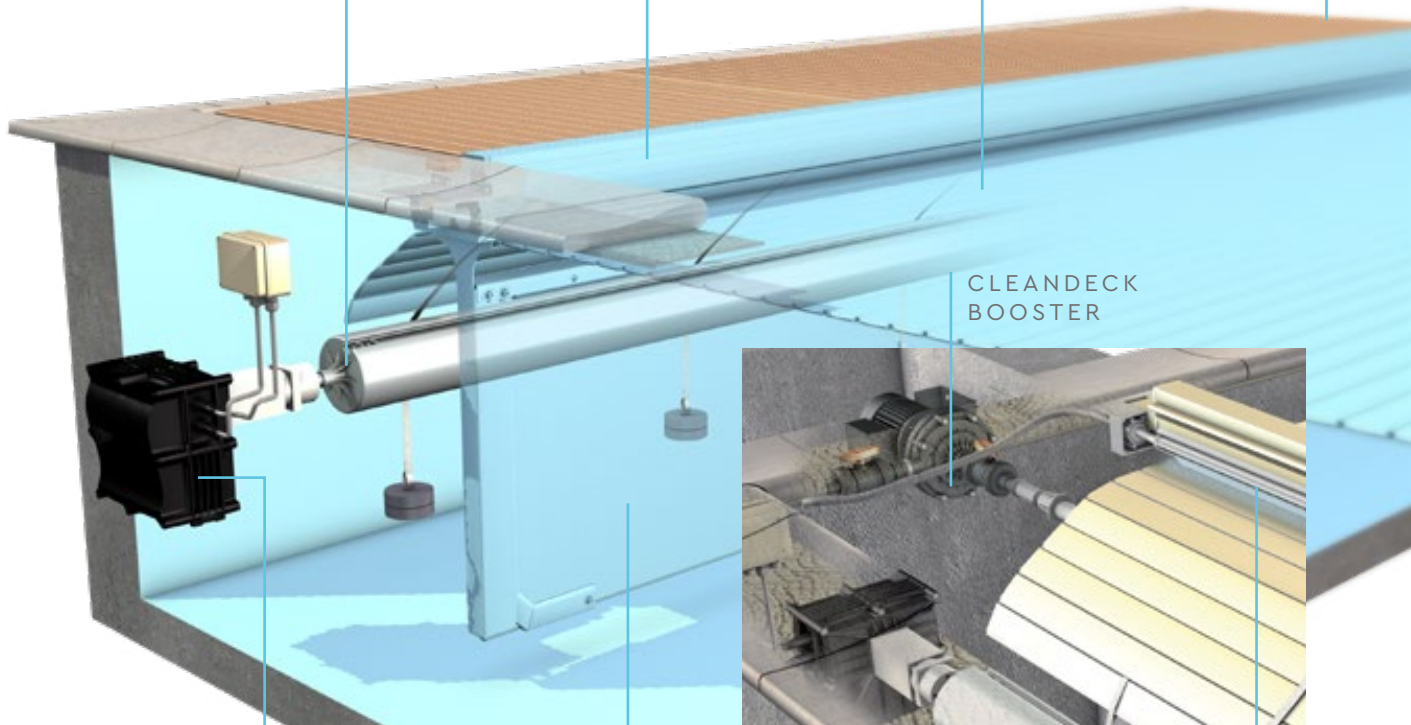

AQUAMAT 3001 OR PL3

reduction geared motor with an electrical protection panel

PIT WALL

Available in 5 colours:

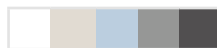

CLEANDECK BOOSTER

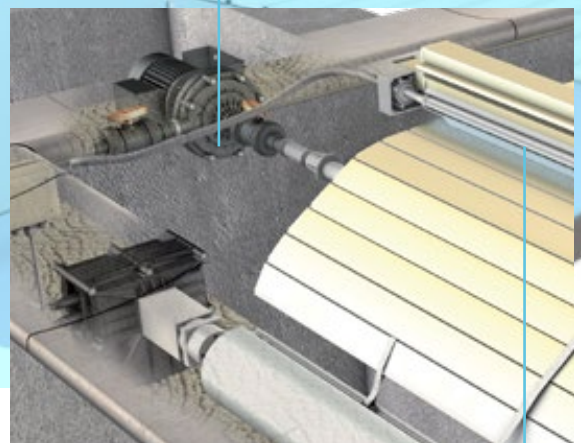

CLEANDECK MANIFOLD



Aesthetic perfection and technical prowess



"LOCK" SAFETY FASTENER SYSTEM

Lock safety fasteners are available in a wide range of colours.

A choice of 12 colours, similar to the liner colours: White, Light Blue, Blue Grey, Dark Blue, Mint, Beige, Taupe, Clay, Grey, Anthracite Grey, Black and Translucent Blue



Stepped
finish



Shaped
finish

STEPS

BWT covers can be manufactured to fit straight steps, roman steps, even free-form steps. Two types of finish are available: stepped or smooth.

MAXIMUM DIMENSIONS

The maximum dimensions of a Stardeck cover are 12.09 m x 25 m (with a PL3 motor and Ø 250 mm axle).

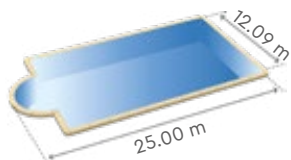

EASY TO USE

A key operated switch, mounted near the pool and out of reach of children, commands operation of the slat cover while allowing the user to keep an eye on the pool to ascertain that no-one remains in the water while the cover is moving.



PIT WALL

Each pit wall is custom made in the factory. Pit walls are compatible with all pool water proofing methods (tiles, liner, reinforced PVC, etc.). The Stardeck pit wall mounting plates are fitted under the coping on either side of the pool, the pool waterproofing is not pierced.

STARDECK HIGH LEVEL



See page 6 for more details



COMPATIBILITY

Compatible with all pool waterproofing finishes (tiles, liner, reinforced PVC, etc.).

PIT WALL

The Stardeck pit wall mounting plates are fitted under the coping on either side of the pool, the pool waterproofing is not pierced.

HIGH WATER LEVEL BRACKET

The black, anodised aluminium brackets were purpose designed for pools with a water level 50 mm from the top of the pool wall (pools fitted with mirror skimmers), they should be installed at 1 m intervals along the pool width. The brackets can bear the weight of the duck boarding and a person weighing up to 80 Kg, thus eliminating the need for a beam.

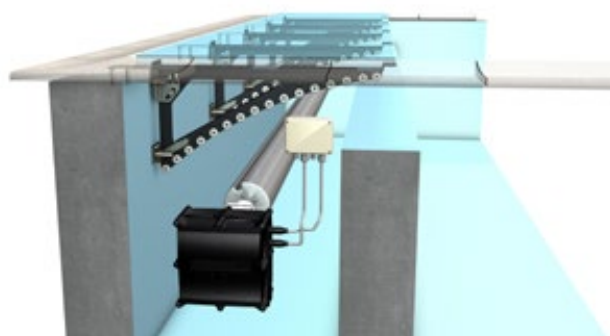

DUCKBOARDING

The Stardeck High Water Level cover is fitted with duckboarding made of Masaranduba, a very dense species of exotic wood that, together with the brackets, can bear the weight of an 80 kg person.

This wood is water resistant, its reddish brown colour is not altered, a beautiful finishing touch to your cover.

INNOVATION

The motor, installed in a dry pit hidden under the deck, is easily accessible. Stardeck is compatible with all types of pool waterproofing (tiles, liner, reinforced PVC membrane, etc.).

By fitting your pool with mirror skimmers from the BWT range, you can raise the water level to only 5 cm from the top of the pool wall.

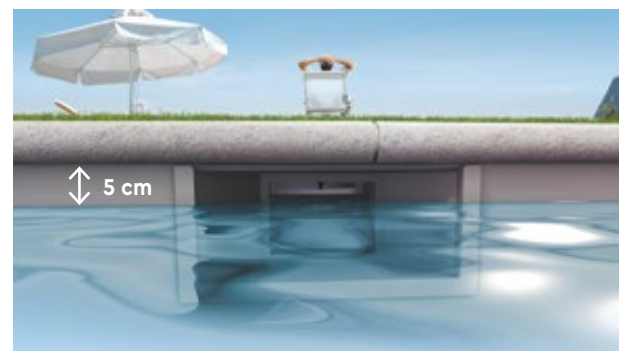



A flawless finish

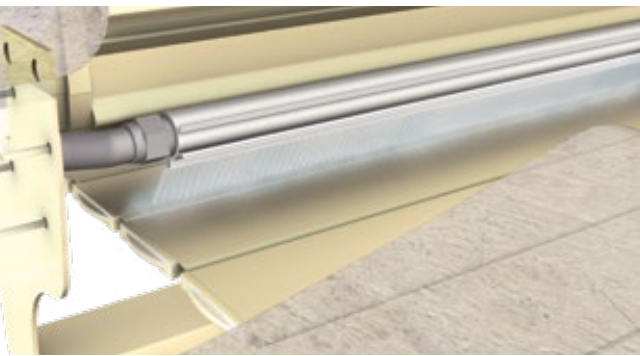

Cleandeck for even more comfort

Stardeck covers can be fitted with a cleaning system, Cleandeck, that washes the slat cover down every time it rolls past, removing dirt and leaves.

Less toil, more play.



PIT WALL COMPONENTS

- 2 mass tinted PVC lateral guide braces,
- 1 mass tinted decorative PVC strip, reinforced with an aluminium bar,
- 1 Pit wall comprising 40 mm thick, mass tinted PVC panels designed to fit together.



MAXIMUM DIMENSIONS

The maximum dimensions of a Stardeck high water level cover are 12.09 m x 18 m.

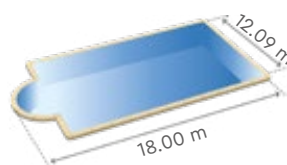

STARDECK INÉO



See page 6 for more details.



DEFLECTERS

STRAPS
Elastane

DUCKBOARDING
available in PVC
(5 colours), or in ready to
tile or ready to weld.



ALUMINIUM BEAM
available in 1 colour.



ANODISED
ALUMINIUM AXLE
ASSEMBLY

Ø 150 mm, 180 mm
or 250 mm



A flawless finish

A range of covers to suit numerous configurations

Shallow installation of the cover:

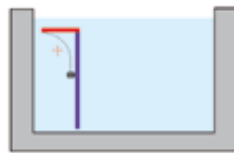

with masonry pit wall

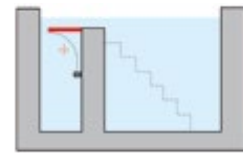

with pre-fabricated pit wall

Deep installation of the cover:



with masonry pit wall



with pre-fabricated pit wall

MAXIMUM DIMENSIONS

The maximum dimensions of a Stardeck Inéo cover are 8.09 × 14 m, axle depth included.

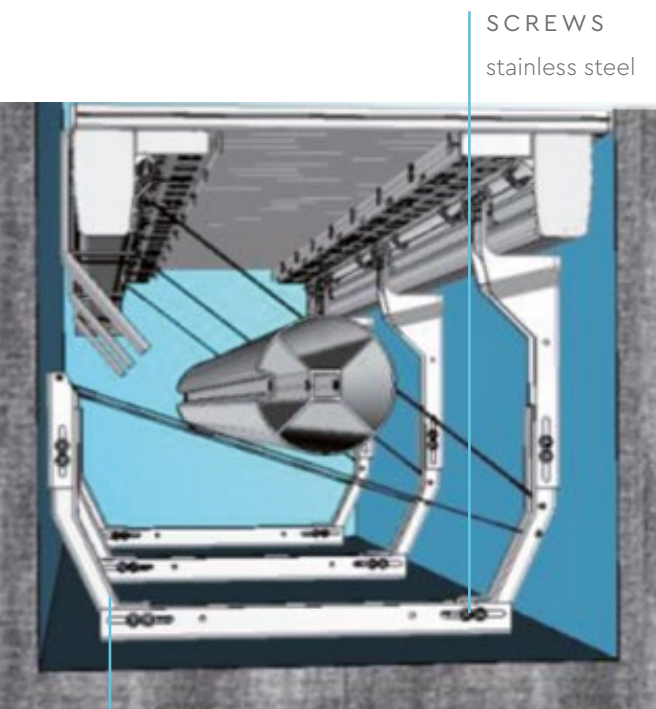

ADJUSTABLE CRADLES
ABS

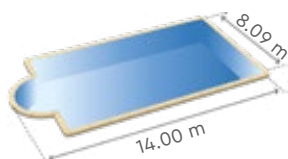

STARDECK INÉO



See page 6 for more detail.



PREFABRICATED
PIT WALL





The best of protection

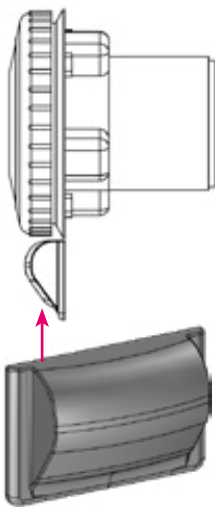

Deflector



ADVANTAGES

- Visual appeal
- Suited to numerous configurations
- Saves space in the pool
- A prefabricated pit wall can be adapted to pools fitted with Inéo covers.

CONSTRAINTS

- Not compatible with liner pools
- Requires a main drain and a return fitting in the cover pit.

THE DEFLECTORS

- Guide the cover while the first few meters are rolling out,
- The number of deflectors required will depend on the pool configuration,
- Position on the beam can be adapted to requirements (steps, cut-outs, etc.).

THE CRADLES

- Keep the cover wound tight when it is rolled up.
- Allow for replacement of the counter weights,
- The number of cradles required will depend on the pool configuration,
- The cradles can be adjusted to suit the cover pit dimensions (+/-20 mm).





MAINTENANCE MADE EASY

BWT covers require little maintenance; they are designed to stay clean. When it comes to winterizing, BWT facilitates your life even further: the motor block on the motorised models is very light and can be removed with no tools in just a few seconds.

Summer and winter, BWT, offers the best possible protection.

REDUCES EVAPORATION FROM INDOOR POOLS

On indoor pools, the cover slats form an effective barrier that prevents evaporation and subsequent condensation on walls and windows. This barrier also significantly reduces heat loss and generates cost savings.

UNRIVALLED KNOW-HOW

The BWT range offers years of experience along with state-of-the-art manufacturing tools to ensure a top quality, repeatable and rigorously monitored production process.



See page 6 for more details.



LÉGAL INFORMATION



All BWT covers comply with the French standard NF P 90-308 (May 2004 version concerning pool protection) if all items comprising the cover are supplied by Procopi.

Pool safety cover intended to deny children under five access to the pool. This cover is no substitute for common sense or individual responsibility. Nor is it intended to replace the vigilance of parents and/or responsible adults that remains the key factor in ensuring the safety of young children.





PROCOPI S.A.S.

Les Landes d'Apigné – B.P. 45328
35653 LE RHEU Cedex – FRANCE

☎ + 33 2 99 14 78 78 📠 + 33 2 99 14 59 05
✉ rennes@procopi.com

procopi.com

Dealer's stamp:

A large, empty rectangular box with a thin black border, intended for a dealer's stamp or signature.